

Model 223-I / Model 234-I
Model 238-I







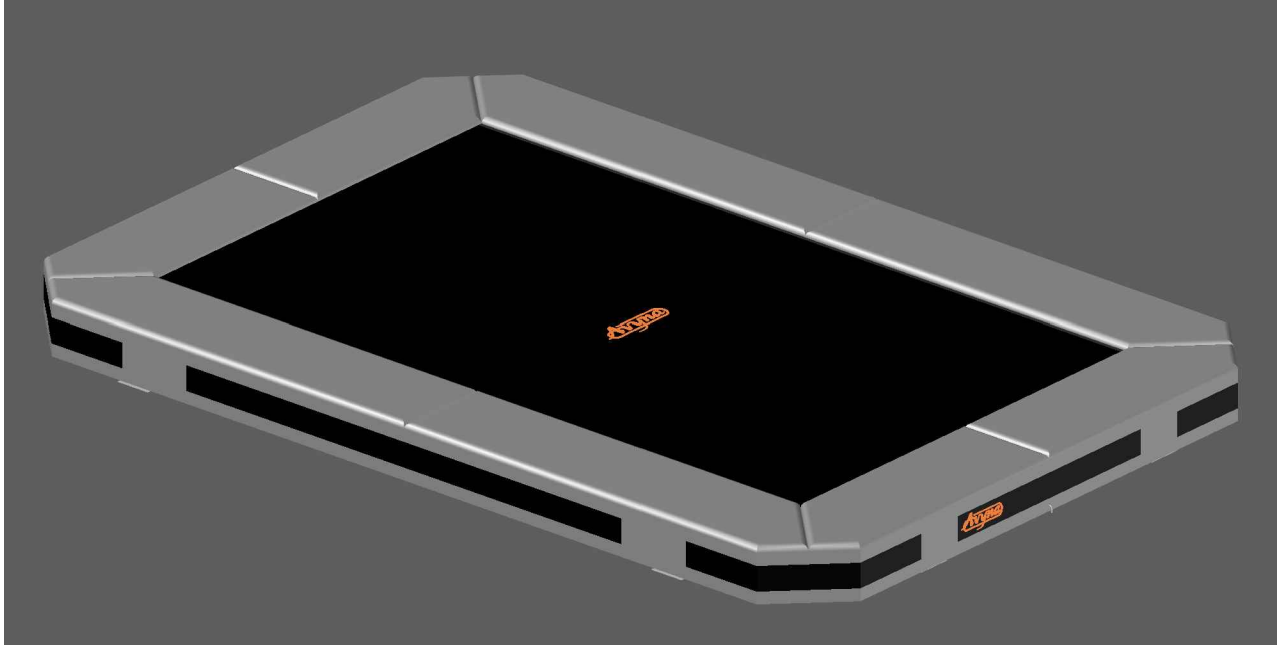

Avyna





Rectangular trampolines

Assembly manual

Model 223-I / Model 234-I
Model 238-I



| | | Model 223-I APPROX 305x225cm | | Model 234-I APPROX 340x240cm | | Model 238-I APPROX 380x255cm | |
|-------------------------------------|--|---------------------------------|--|---------------------------------|--|---------------------------------|--|
| | | Quantity | Part number | Quantity | Part number | Quantity | Part number |
| Jumping mat |  | 1 | TEPL-223-I-222 | 1 | TEPL-234-I-222 | 1 | TEPL-238-I-222 |
| Galvanized spring L=215mm Ø3.2mm |  | | TEPL-200-211/A | 78 | TEPL-200-211/A | 90 | TEPL-200-211/A |
| Galvanized spring L=175mm Ø3.2mm |  | 74 | TEPL-200-211/C | 4 | TEPL-200-211/C | 4 | TEPL-200-211/C |
| Galvanized spring L=140mm Ø3.2mm |  | 4 | TEPL-200-211/E | | | | |
| Safety pad |  | 1 | TEPL-223-I-333-green or AVGR-223-I-333-grey or CAM-223-I-333-camouflage OR AVBL-223-I-black | 1 | TEPL-234-I-333-green or AVGR-234-I-333-grey or CAM-234-I-333-camouflage OR AVBL-234-I-black | 1 | TEPL-238-I-333-green or AVGR-238-I-333-grey or CAM-238-I-333-camouflage or AVBL-238-I-333-black |
| Fastener for Safety pad |  | 8 | TEPL-ELAS-A | 12 | TEPL-ELAS-A | 12 | TEPL-ELAS-A |
| Inground pin |  | 8 | TEPL-PIN | 8 | TEPL-PIN | 8 | TEPL-PIN |
| K-tube |  | 2 | TEPL-223-1141 | 2 | TEPL-234-1141 | 2 | TEPL-238-1141 |

| | | Model 223-I APPROX 305x225cm | | Model 234-I APPROX 340x240cm | | Model 238-I APPROX 380x255cm | |
|--------------------------|---|---------------------------------|--------------|---------------------------------|--------------|---------------------------------|--------------|
| | | Quantity | Part number | Quantity | Part number | Quantity | Part number |
| C-tube |  | 2 | TEPL-223-112 | 2 | TEPL-234-112 | 2 | TEPL-238-112 |
| Tool for spring |  | 1 | TOOL-SPRING | 1 | TOOL-SPRING | 1 | TOOL-SPRING |
| Inground pin |  | 8 | TEPL-SP-PIN | 12 | TEPL-SP-PIN | 12 | TEPL-SP-PIN |
| Fastener for Safety pad |  | 20 | TEPL-ELAS-B | 20 | TEPL-ELAS-B | 20 | TEPL-ELAS-B |
| Users Manual | | 1 | 208010101 | 1 | 208010101 | 1 | 208010101 |
| Warning Card | | 1 | 208040101 | 1 | 208040101 | 1 | 208040101 |
| Tie rip for warning card | | 1 | 209010102 | 1 | 209010102 | 1 | 209010102 |
| Safety manual | | 1 | 208010301 | 1 | 208010301 | 1 | 208010301 |

1.

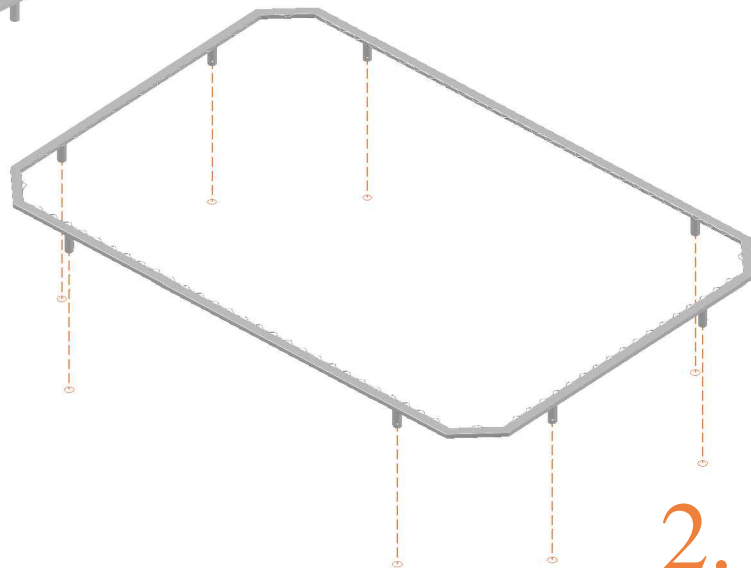
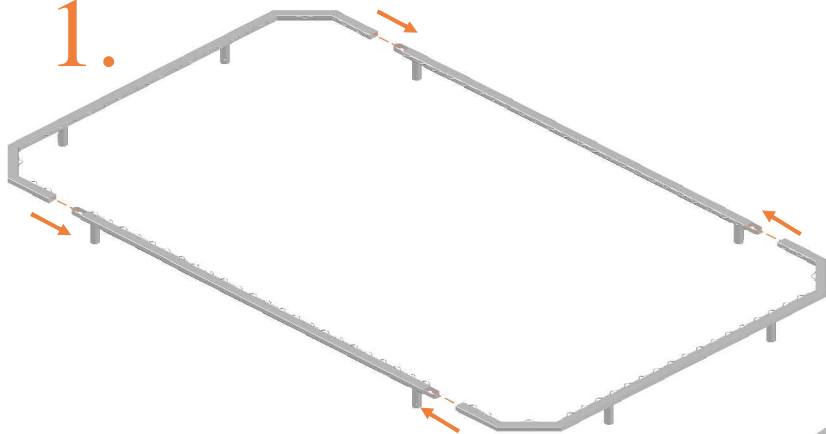

2.

3.

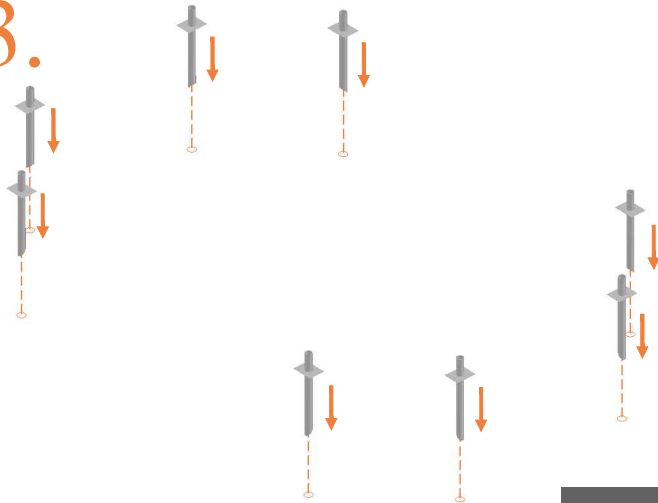

223-I : Max 20cm
234-I / 238-I : Max 25cm

223-I : Min 60cm
234-I / 238-I : Min 80cm

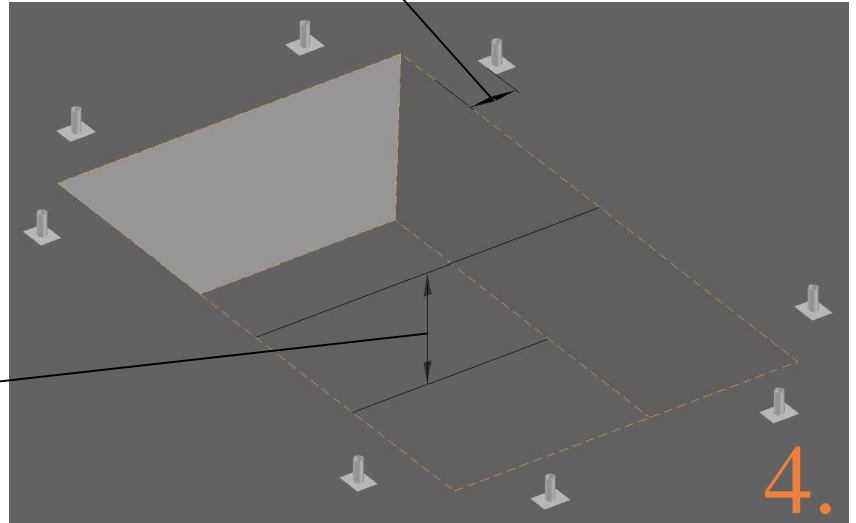

4.

5.

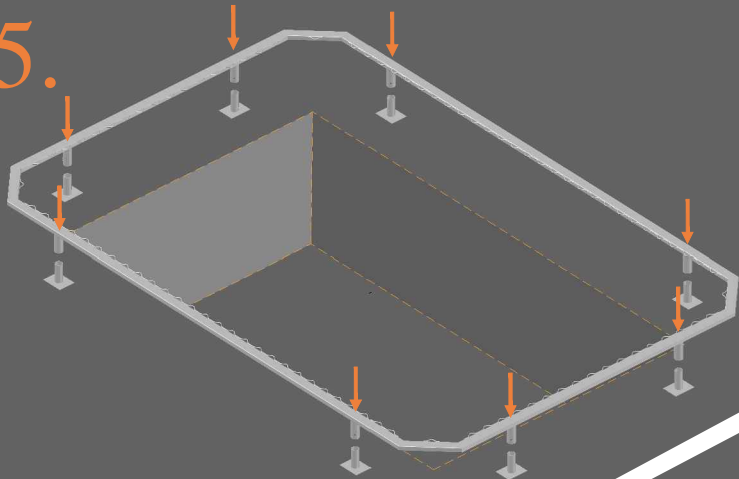

223: 4x spring 140mm
234 / 238 :4x spring 175mm

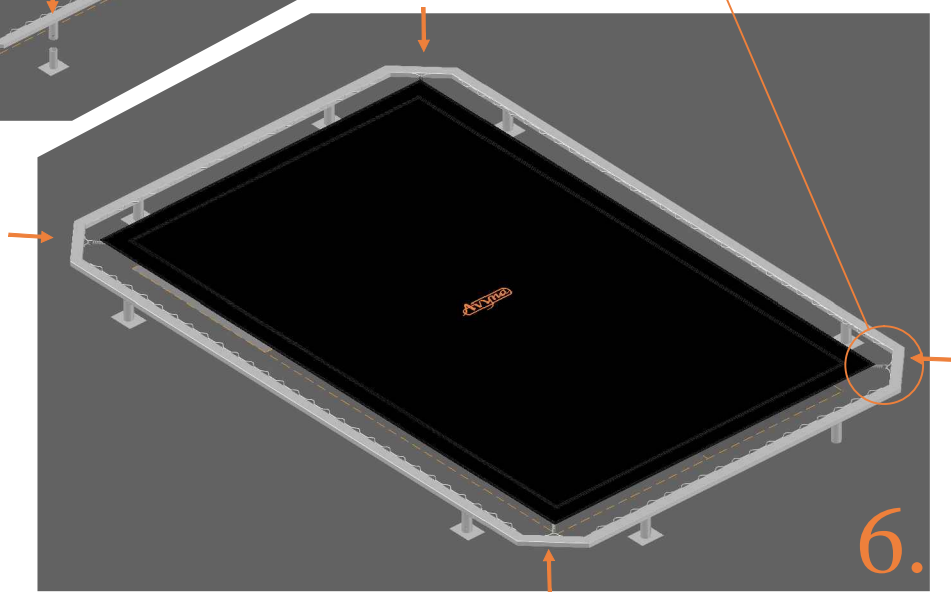
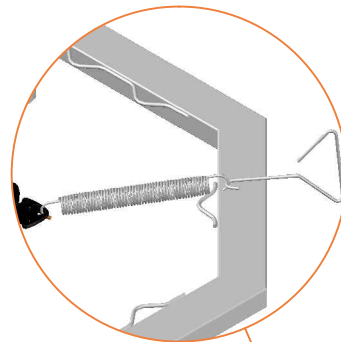

6.

7.

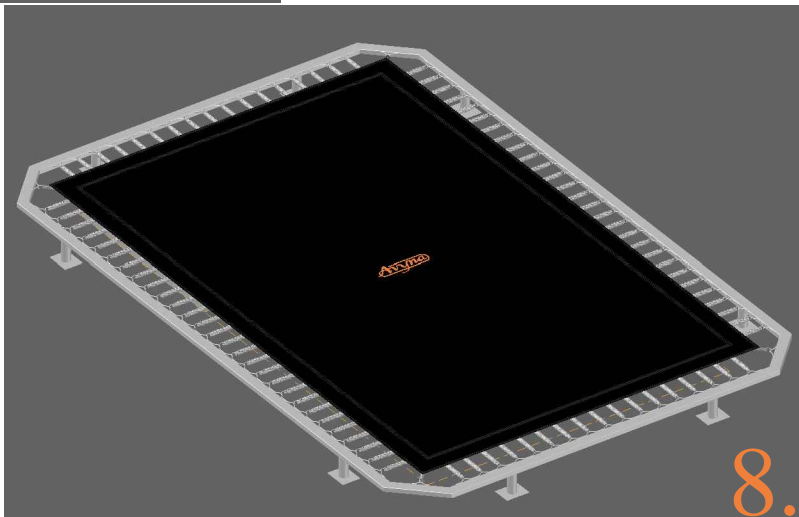
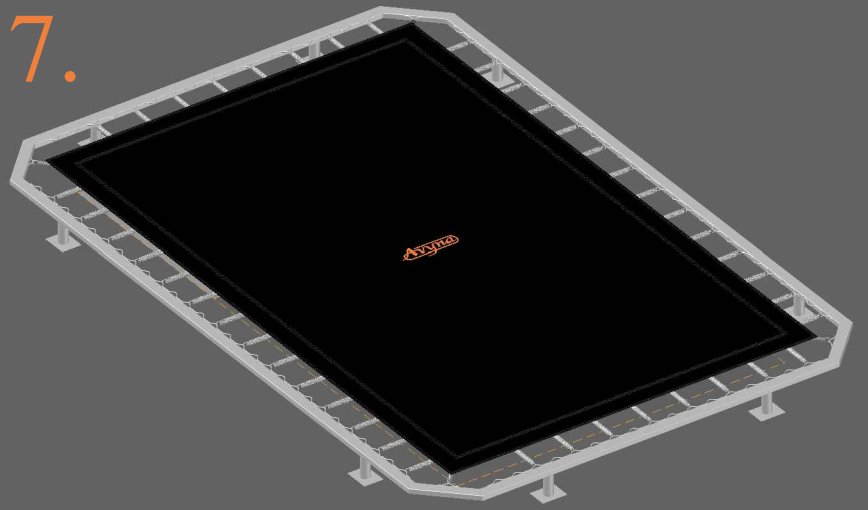

8.

9.

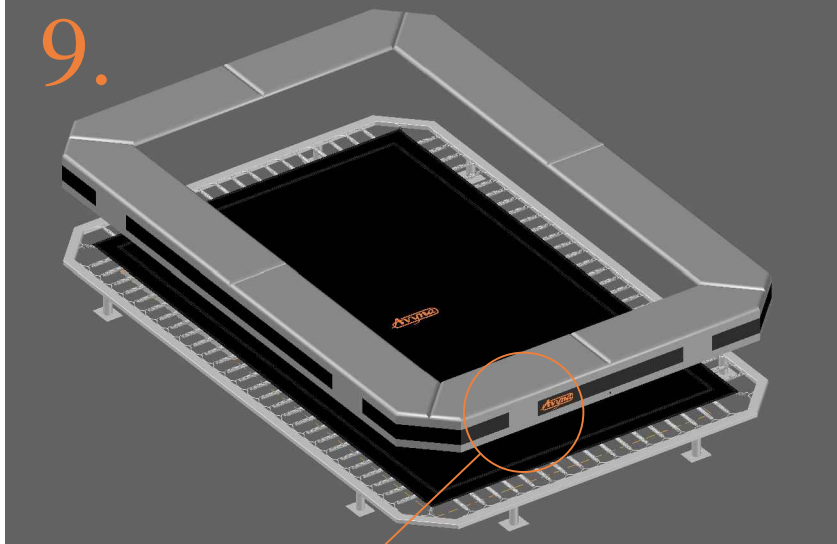

TEPL-ELAS-A 223-i : 8x
234-i / 238-i: 12x

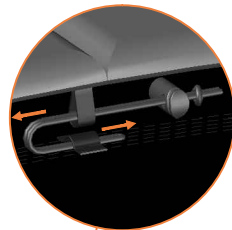
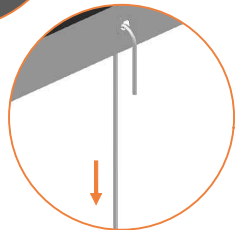
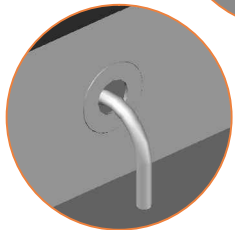
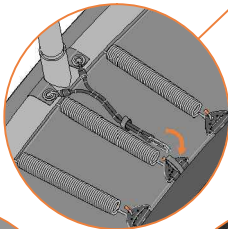

TEPL-ELAS-B

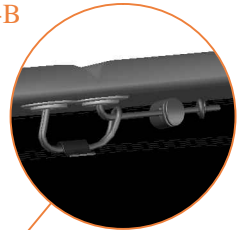
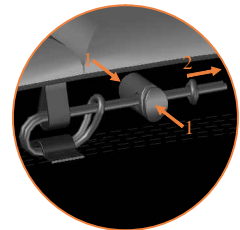

TEPL-ELAS-B



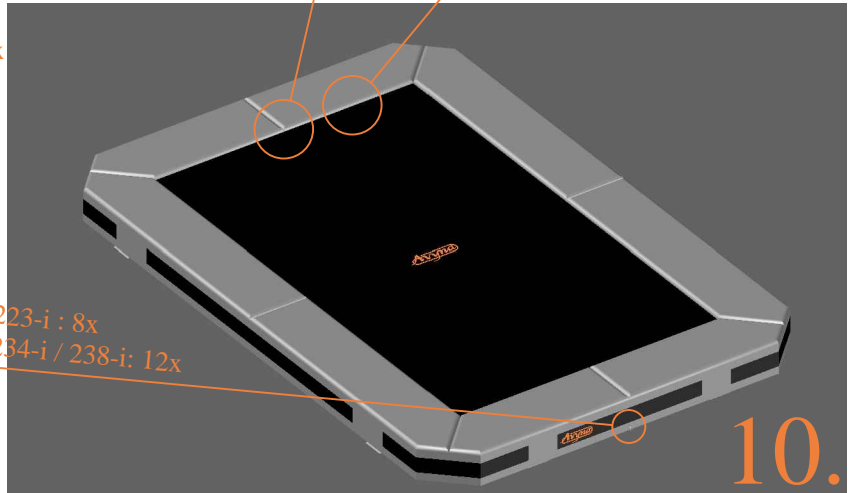





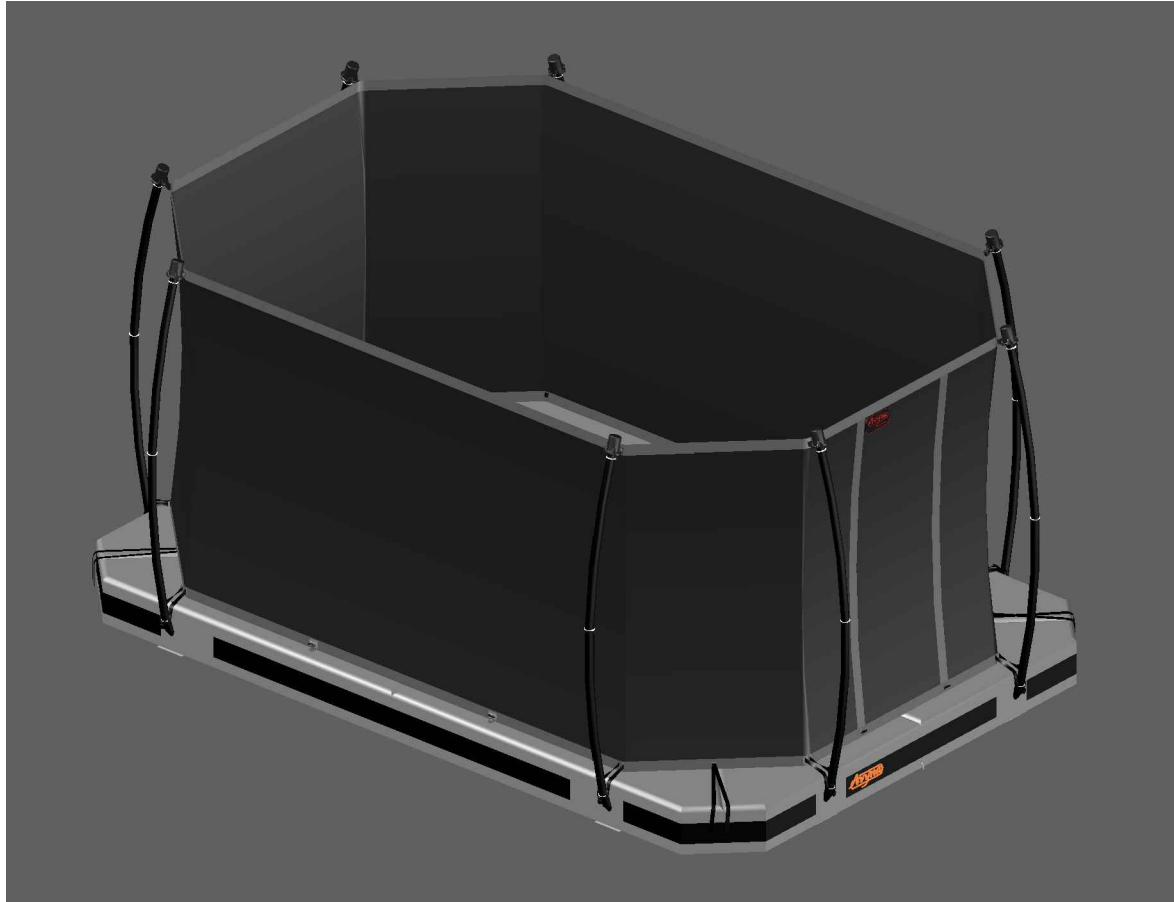

223-i : 8x
234-i / 238-i: 12x



10.

Model 223-I / Model 234-I / Model 238-I



| | | Model-223-I APPROX 305x225cm | | Model-234-I APPROX 340x240cm | | Model-238-I APPROX 380x255cm | |
|---------------------------------|--|---------------------------------|---|---------------------------------|---|---------------------------------|---|
| | | Quantity | Part number | Quantity | Part number | Quantity | Part number |
| Pole with sleeve for safety net |  | 8 | AVBL-223-i-802 A | 8 | AVBL-234-i-802 A | 8 | AVBL-238-i-802 A |
| Pole for safety net |  | 8 | AVBL-223-i-802 B | 8 | AVBL-234-i-802 B | 8 | AVBL-238-i-802 B |
| Clamp |  | 8 | CLAMP-TOOL-SN 223-i | 8 | CLAMP-TOOL-SN 234-i | 8 | CLAMP-TOOL-SN 238-i |
| Screw M6x30 |  | 8 | M6x30 | 8 | M6x30 | 8 | M6x30 |
| Safety net |  | 1 | ANBL-223-I | 1 | ANBL-234-I | 1 | ANBL-238-I |
| Straps for safety net |  | 20 | TEPL-BAND 16x short: 1,0m 4x long: 1,5m | 20 | TEPL-BAND 16x short: 1,0m 4x long: 1,5m | 20 | TEPL-BAND 16x short: 1,0m 4x long: 1,5m |
| Closure for safety net |  | 2 | TEPL-KNOOPJE | 2 | TEPL-KNOOPJE | 2 | TEPL-KNOOPJE |
| Fastening for safety net |  | 10 | TEPL-ELAS-C | 10 | TEPL-ELAS-C | 10 | TEPL-ELASTIEK |
| Screw M8 |  | 16 | M8-25 | 16 | M8-25 | 16 | M8-25 |
| Allen key |  | 2 | ALLEN-KEY | 2 | ALLEN-KEY | 2 | ALLEN-KEY |
| Wrench |  | 2 | WRENCH | 2 | WRENCH | 2 | WRENCH |

1.

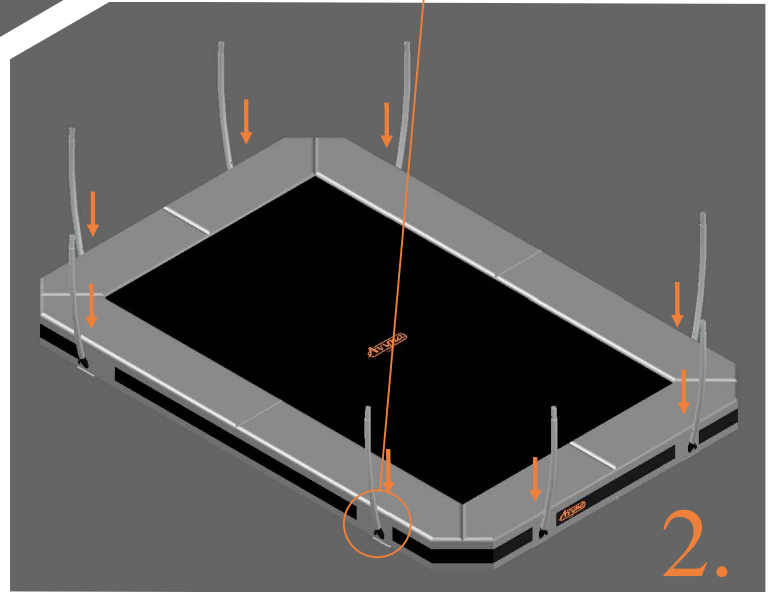
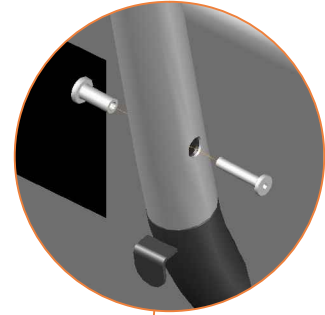
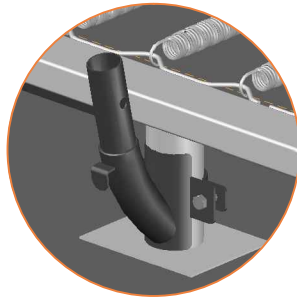
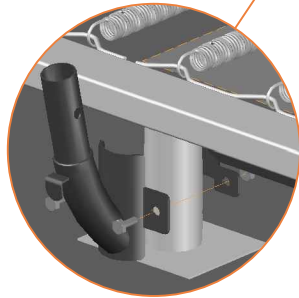
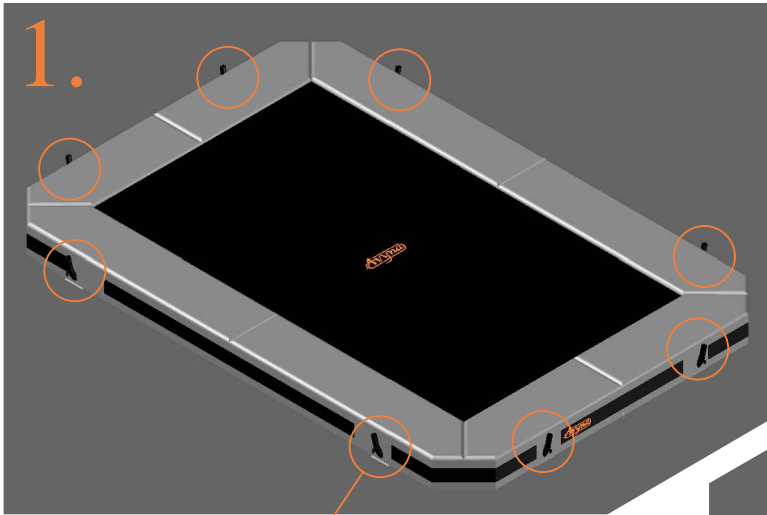

2.

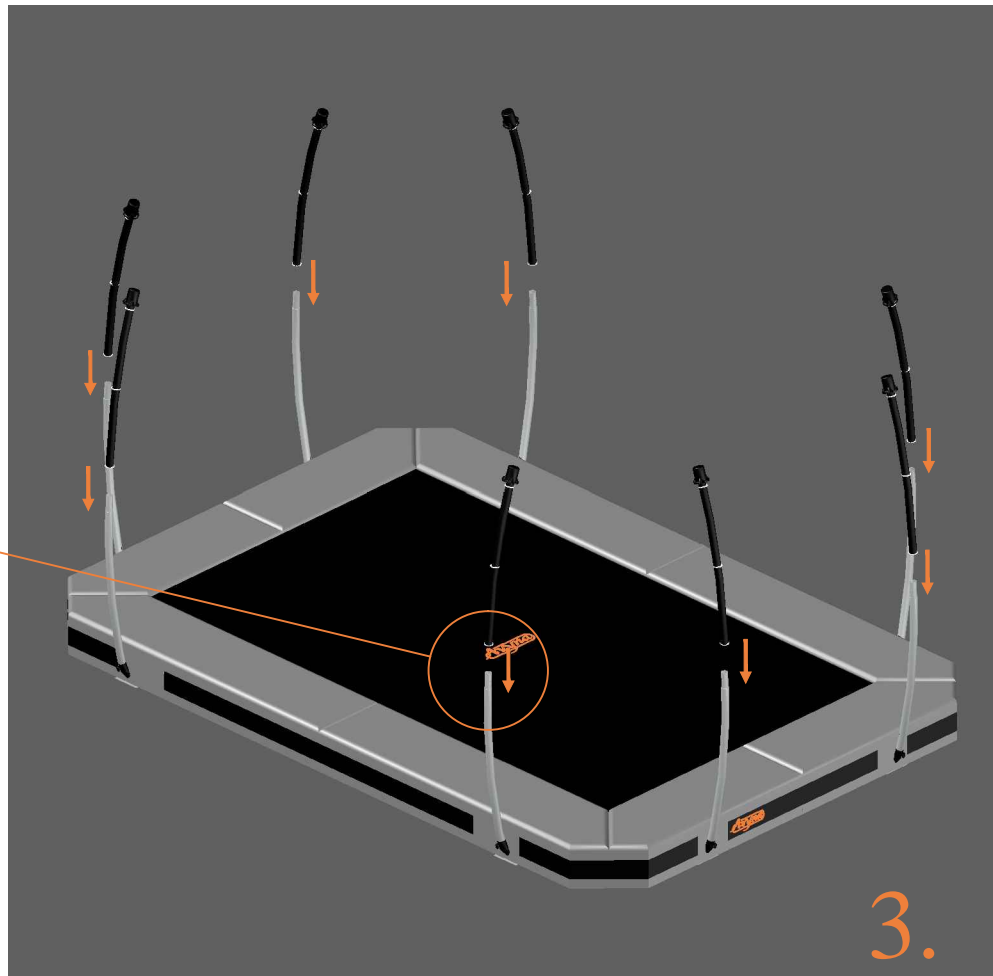
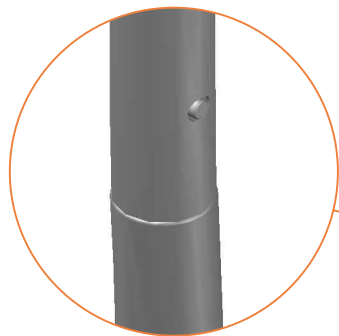

4.



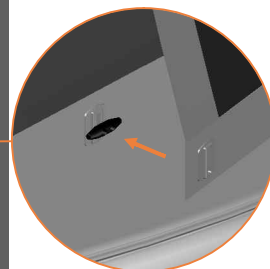
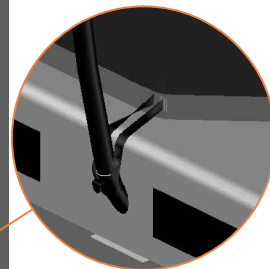
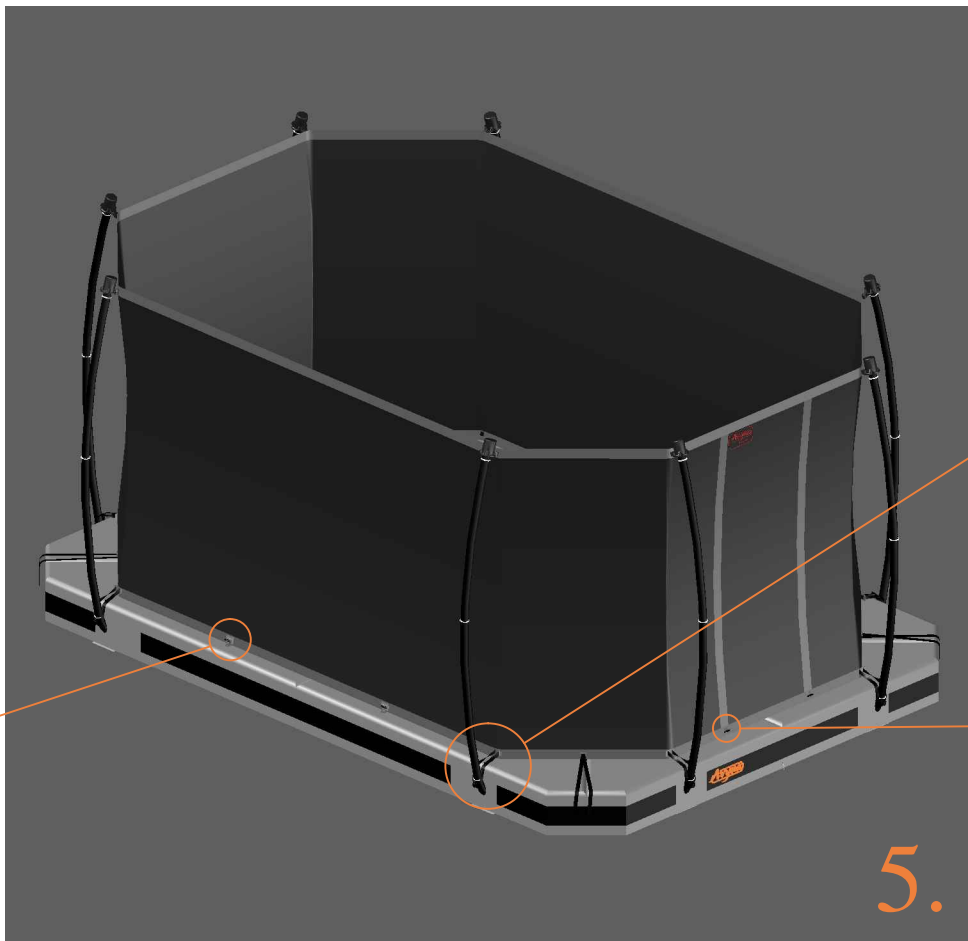
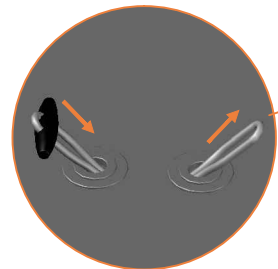
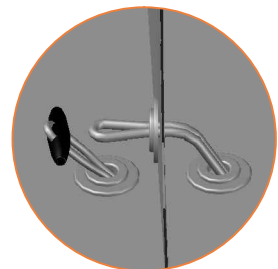

TEPL-ELAS-C

5.



Sales office: Beneluxbaan 7
5121 DC Rijen
The Netherlands
sales@avyna.eu
www.avyna.eu